



# MB Sprinter 2018-

Art. 81885070, 81885071, 818805701, 818805711

Eurobar | Eurobar | Евробар | Eurobar



- |  |    |
|--|----|
| 1. Eurobar / eurobar / евробар / eurobar   | 1  |
| 2. Kronstein / bracket / wspornik / Konsole  | 1  |
| 3. Kronstein / bracket / wspornik / Konsole  | 1  |
| 4. Kronstein / bracket / wspornik / Konsole  | 1  |
| 5. Kronstein / bracket / wspornik / Konsole  | 1  |
| 6. Kronstein / bracket / wspornik / Konsole  | 2  |
| 7. Kronstein / bracket / wspornik / Konsole  | 2  |
| 8. Puks / bushing / tuleja / Buchse  | 2  |
| 9. Puks / bushing / tuleja / Buchse  | 2  |
| 10. T-polt / T-bolt / T-šruba / T-bolzen   | 2  |
| 11. Polt / bolt / šruba / Bolzen M10x25  | 10 |
| 12. Polt / bolt / šruba / Bolzen M8x60   | 2  |
| 13. Polt / bolt / šruba / Bolzen M8x20   | 4  |
| 14. Mutter / nut / nakrętka / Mutter M10 DIN985 galZn                              | 10 |
| 15. Mutter / nut / nakrętka / Mutter M10 DIN934 galZn                              | 2  |
| 16. Seib / washer / podkładka / Scheibe 10,5x30x2,5                                | 22 |
| 17. Seib / washer / podkładka / Scheibe 8,4x24x2                                   | 6  |
| 18. Vedruseib / spring washer / podkładka sprysta / Federnscheibe A10 DIN127 galZn | 2  |
| 19. Vedruseib / spring washer / podkładka sprysta / Federnscheibe A8               | 6  |

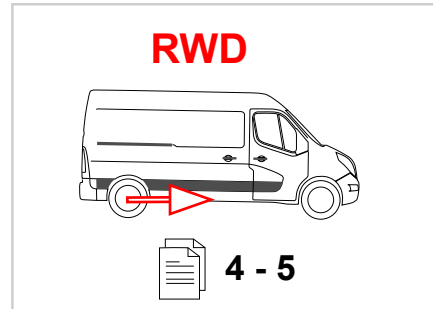
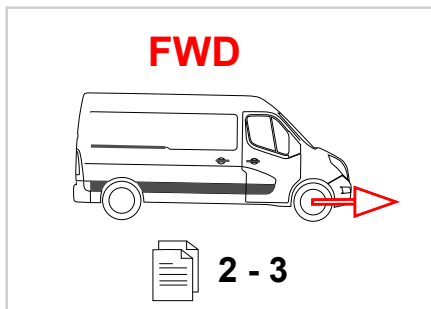

**M8 - 25 Nm**  
**M10 - 50 Nm**

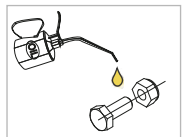

Kaal / Weight / Masa / Gewicht: 8,1 kg

Paigaldusaeg / Time of mounting / Czas montażu / Einbauzeit: 60 min

**Vajalikud tööriistad / Required Tools / Wymagane narzędzia / Benötigte Werkzeuge**



Euroraua paigaldamine esiveolisele mudelile | Installing the eurobar to a front-wheel drive model | Instalacja orurowania do samochodu z napędem na przednie koła | Die Eurobar an einem Modell mit Vorderradantrieb installieren

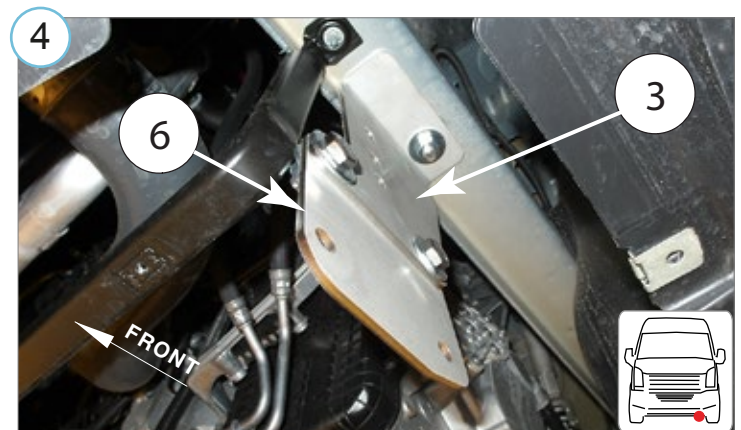
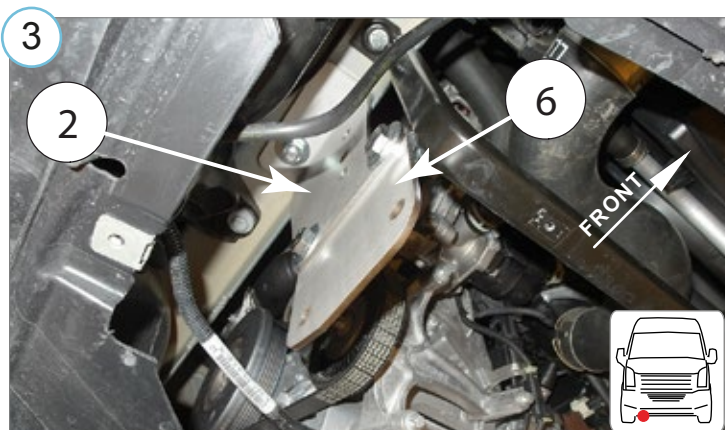
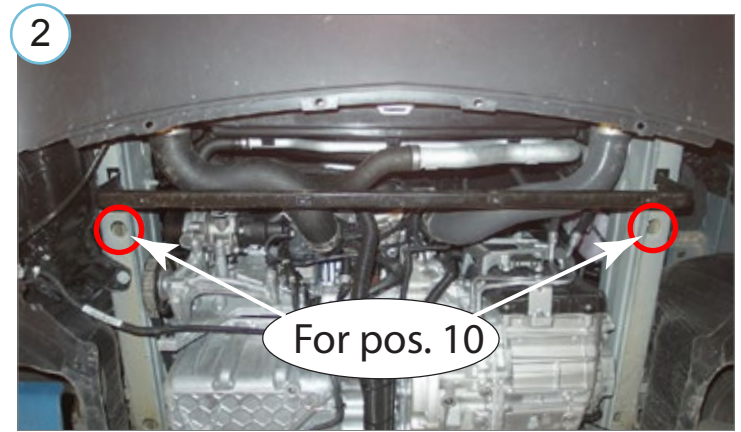
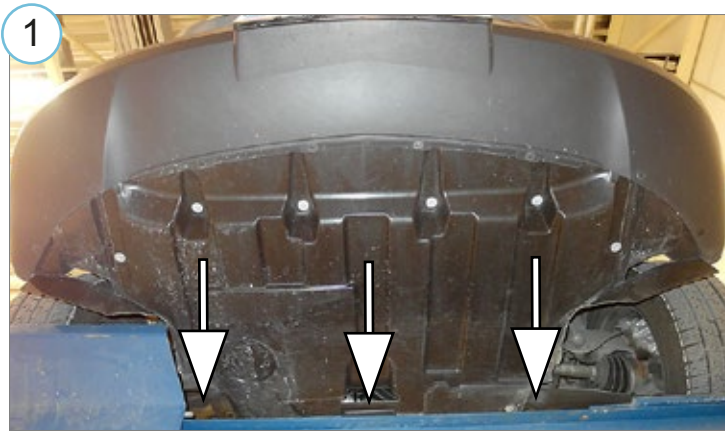
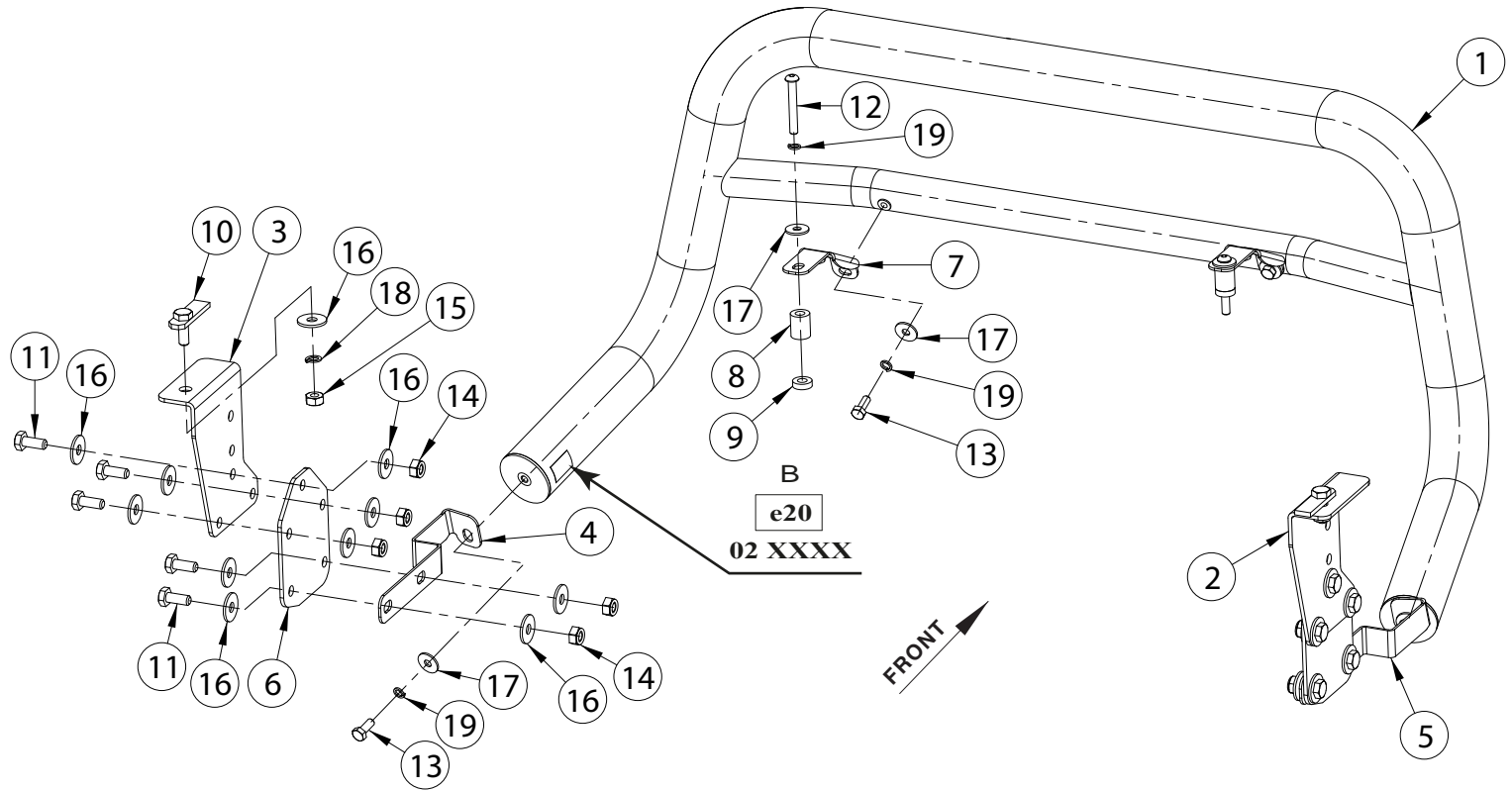

Euroraua paigaldamine esiveolisele mudelile | Installing the eurobar to a front-wheel drive model | Instalacja orurowania do samochodu z napędem na przednie koła | Die Eurobar an einem Modell mit Vorderradantrieb installieren

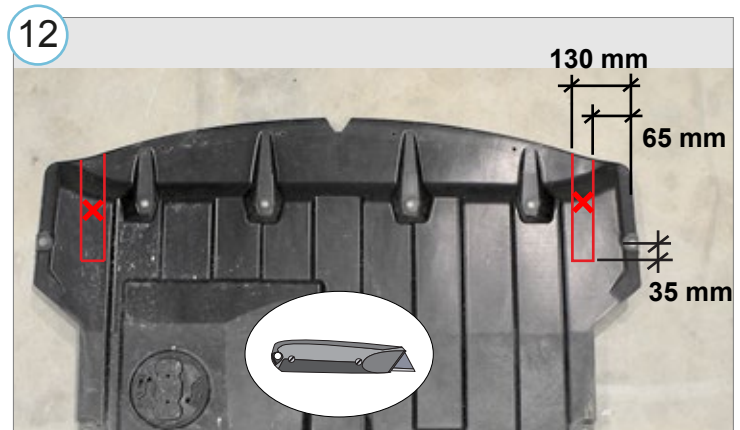
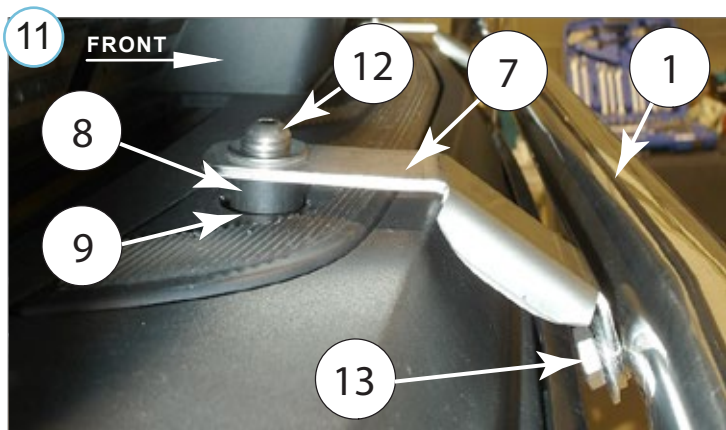
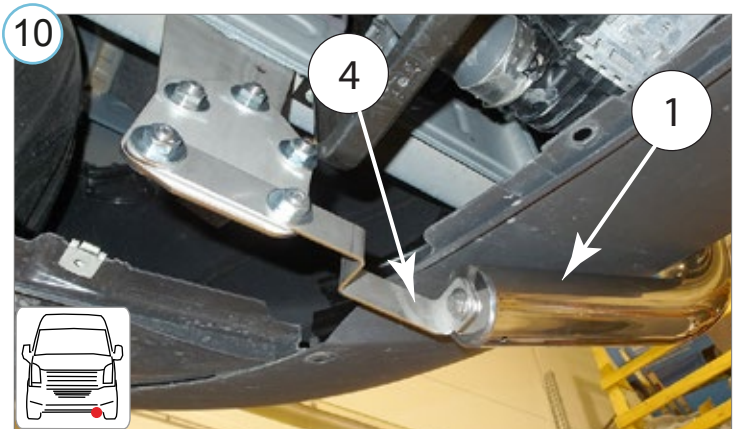
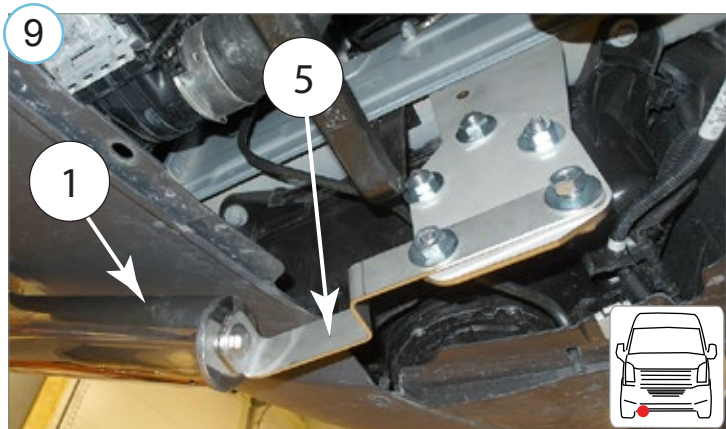
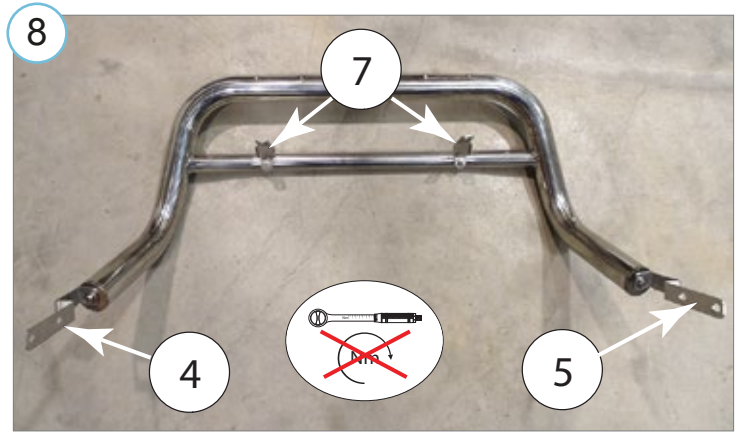
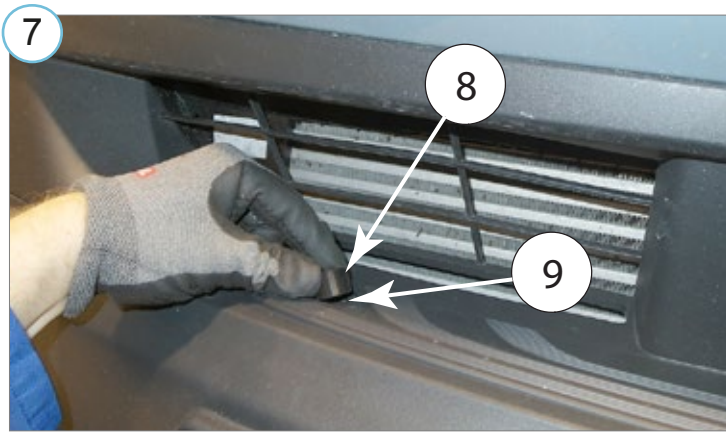
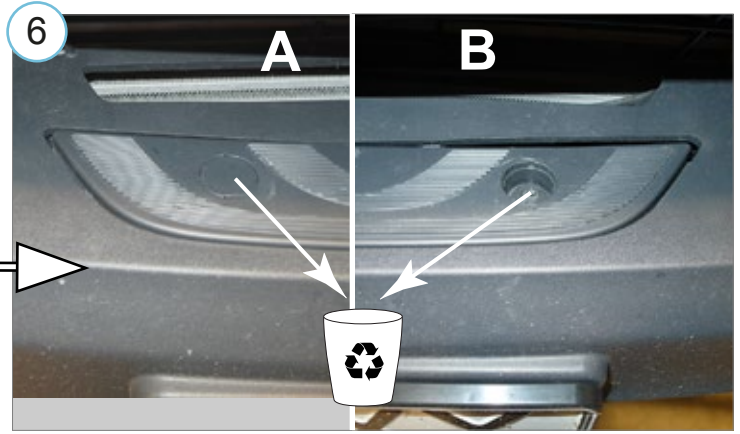
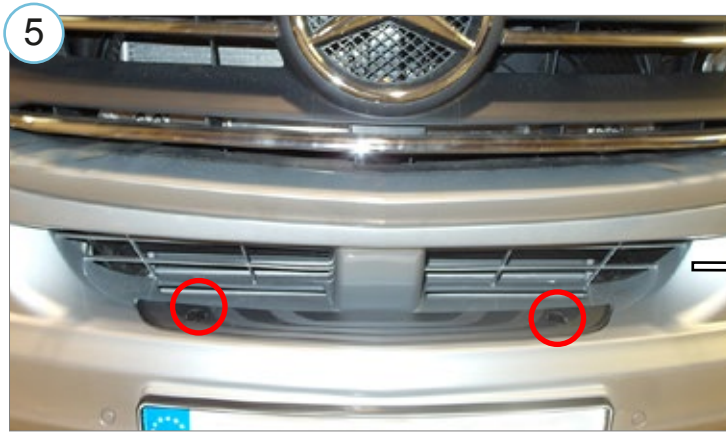

Euroraua paigaldamine tagaveolisele mudelile | Installing the eurobar to a rear-wheel drive model | Instalacja orurowania do samochodu z napędem na tylne koła | Die Eurobar an einem Modell mit Hinterradantrieb installieren

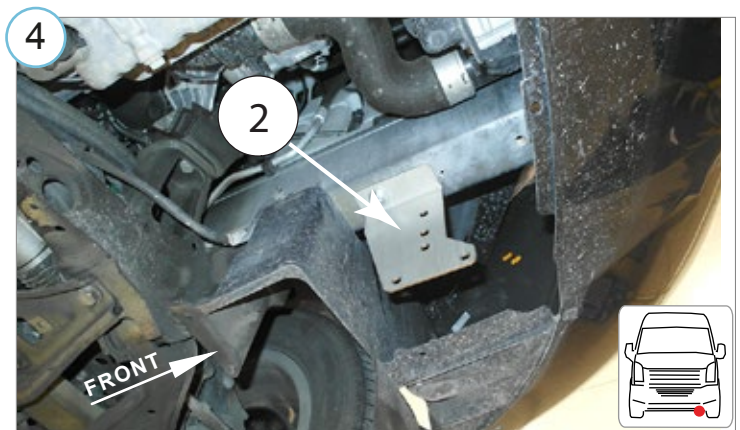
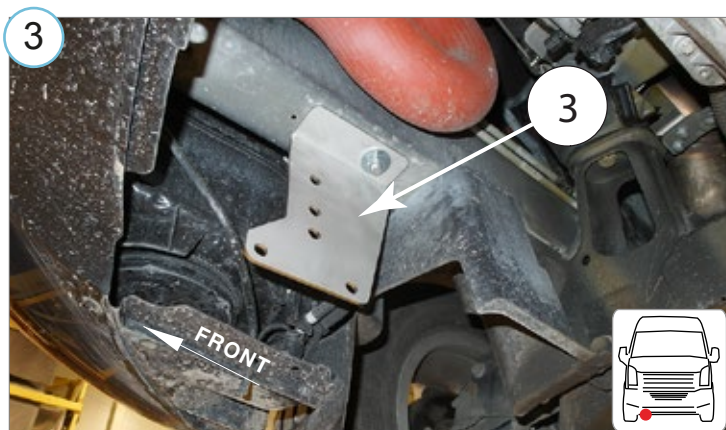
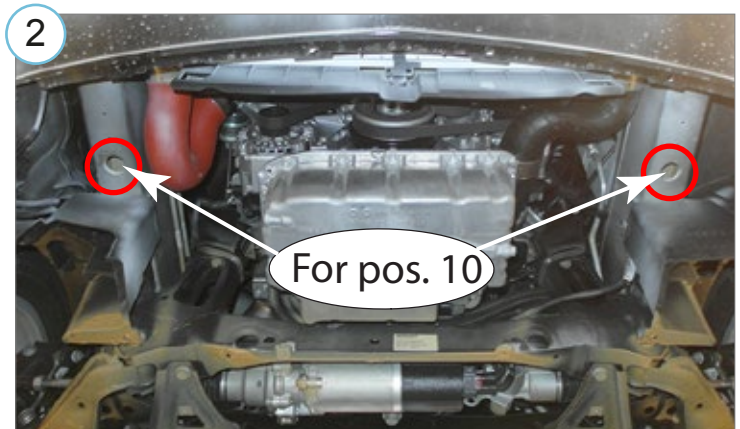
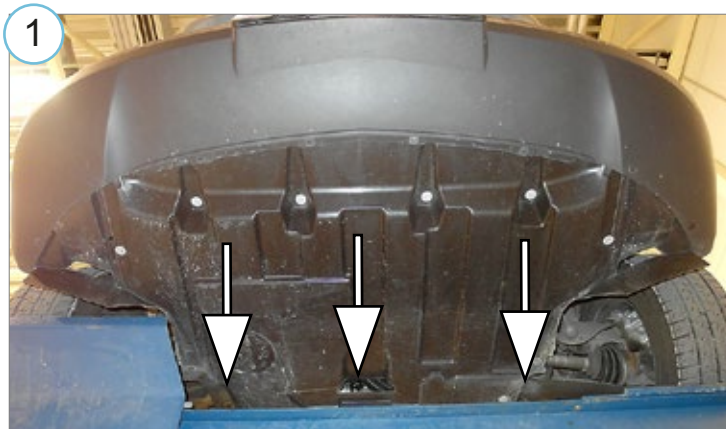
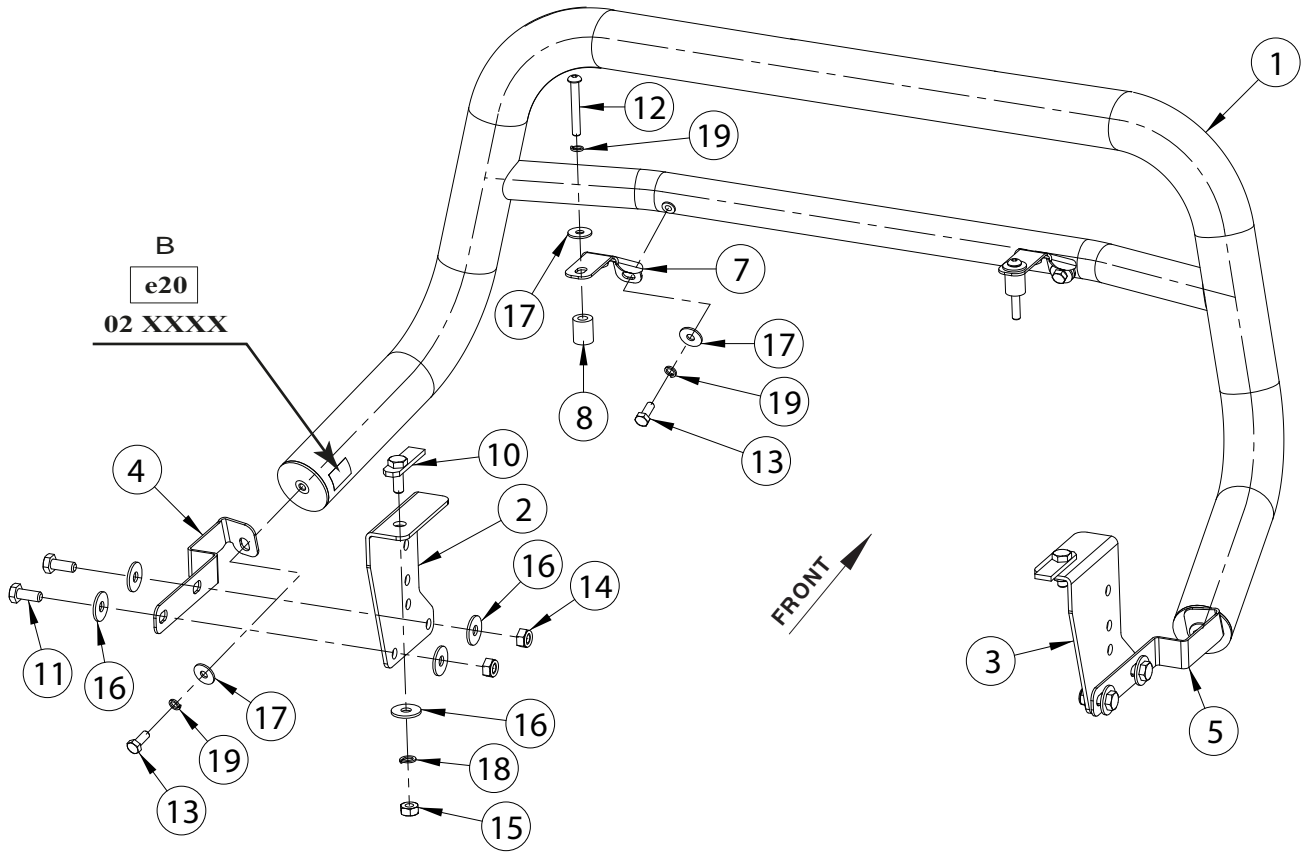

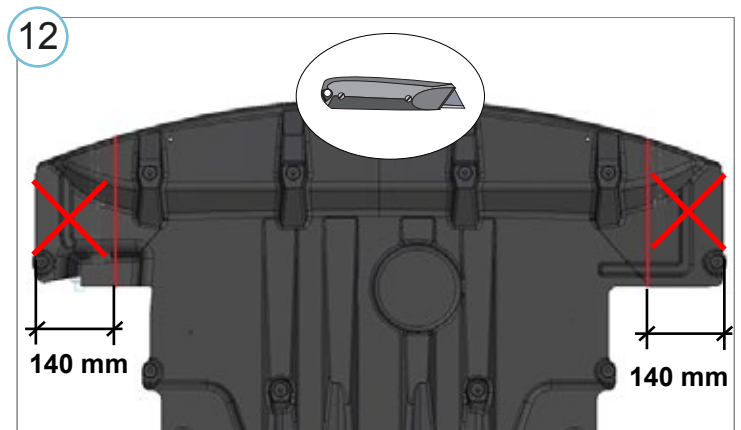
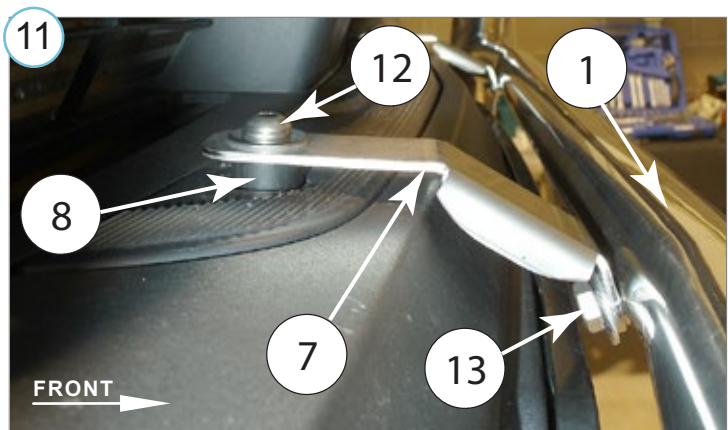
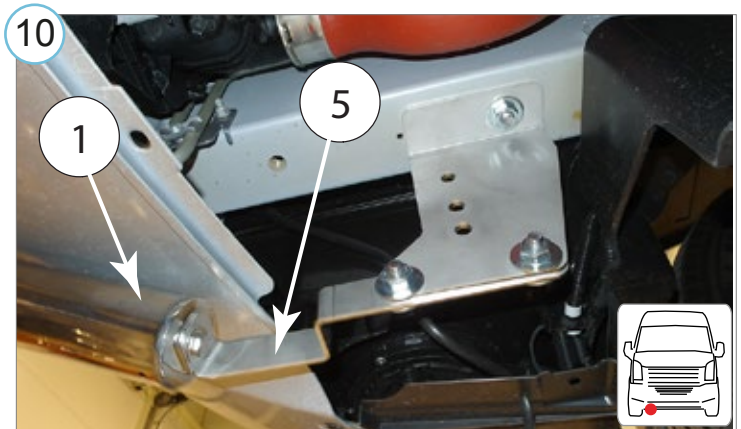
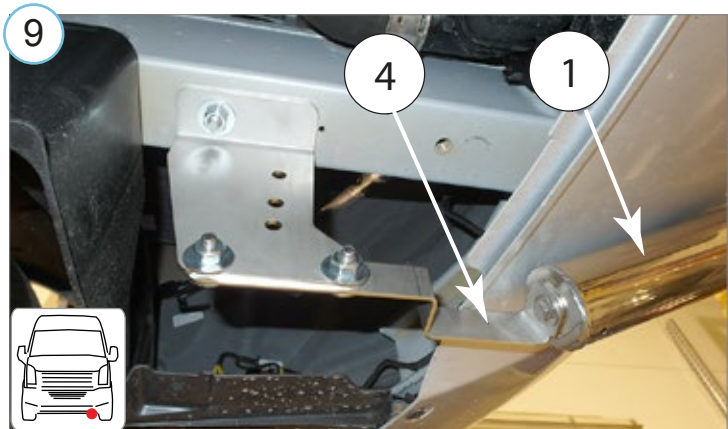
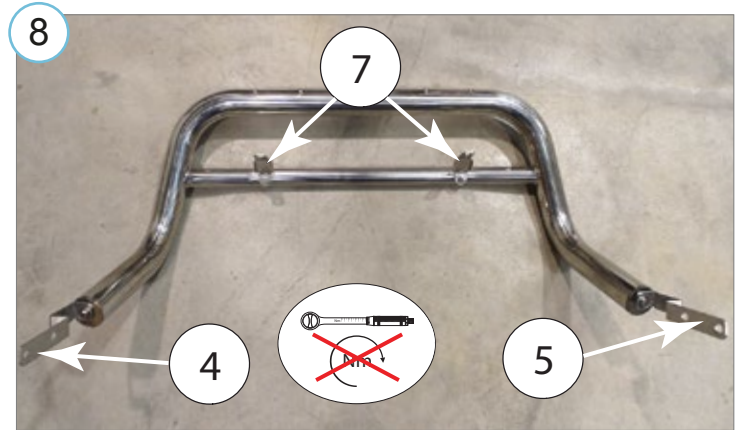
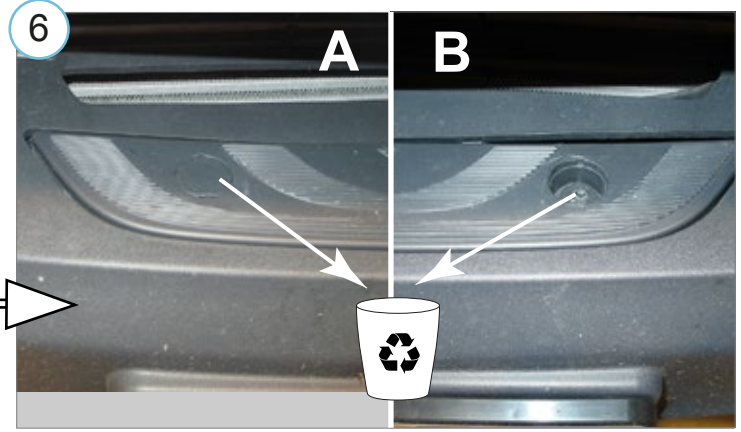

# MB Sprinter 2018-

Eurobar | Eurobar | Евробар | Eurobar

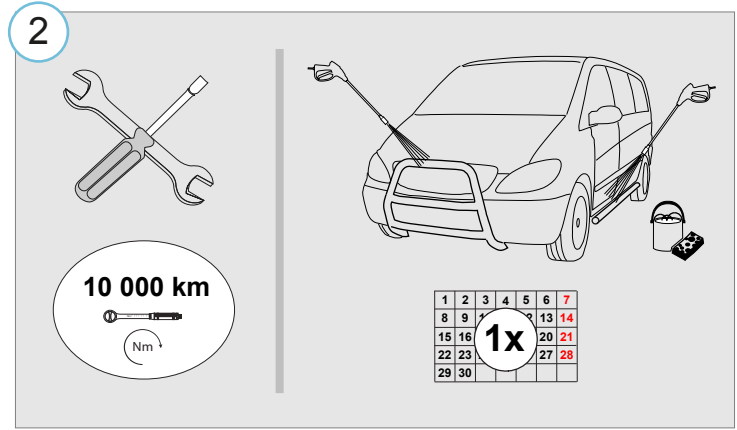

- Kui METEC toode ei vasta Teie ootustele või kui on tegemist toote ebapiisava kvaliteediga, siis pretensioonid esitada lehel [www.metec.ee](http://www.metec.ee)
- If the METEC product does not meet Your expectations or if it is a product of insufficient quality, then you can submit a claim at [www.metec.ee](http://www.metec.ee)
- Jeśli produkt nie spełnia Twoich oczekiwań Meteci, lub jeśli są niewystarczającej jakości, następnie przedstawić roszczeń do [www.metec.ee](http://www.metec.ee) strona
- Wenn METEC Produkt nicht Ihren Erwartungen entspricht oder wenn es um Qualitätsmängel geht, dann bitte die Ansprüche auf Seite [www.metec.ee](http://www.metec.ee) einreichen