



Peugeot Boxer / Citroen Jumper / Fiat Ducato 2007- Opel Movano 2022-

Art. 826145

Stangeääris | Spoilerbar | Спойлербар | Spoilerbar



- | | |
|--|----|
| 1. Look / arc / дуга / Bogen | 1 |
| 2. Polditav kronstein / bolt bracket / кронштейн / Bolzenhalterung | 2 |
| 3. Kronstein / bracket / кронштейн / Konsole | 1 |
| 4. Kronstein / bracket / кронштейн / Konsole | 1 |
| 5. Latt / bracket / кронштейн / Latte | 1 |
| 6. Latt / bracket / кронштейн / Latte | 1 |
| 7. U-polt / U-bolt / U-болт / U-bolzen | 2 |
| 8. Polt / bolt / болт / Bolzen M8x20 | 12 |
| 9. Mutter / nut / гайка / Mutter M8 DIN934-galZn | 4 |
| 10. Mutter / nut / гайка / Mutter M8 DIN985-A2 | 8 |
| 11. Seib / flat washer / шайба / Scheibe 8,4x16x1,6 | 24 |
| 12. Vedruseib / spring washer / пружинная шайба / Federnscheibe A8 | 8 |

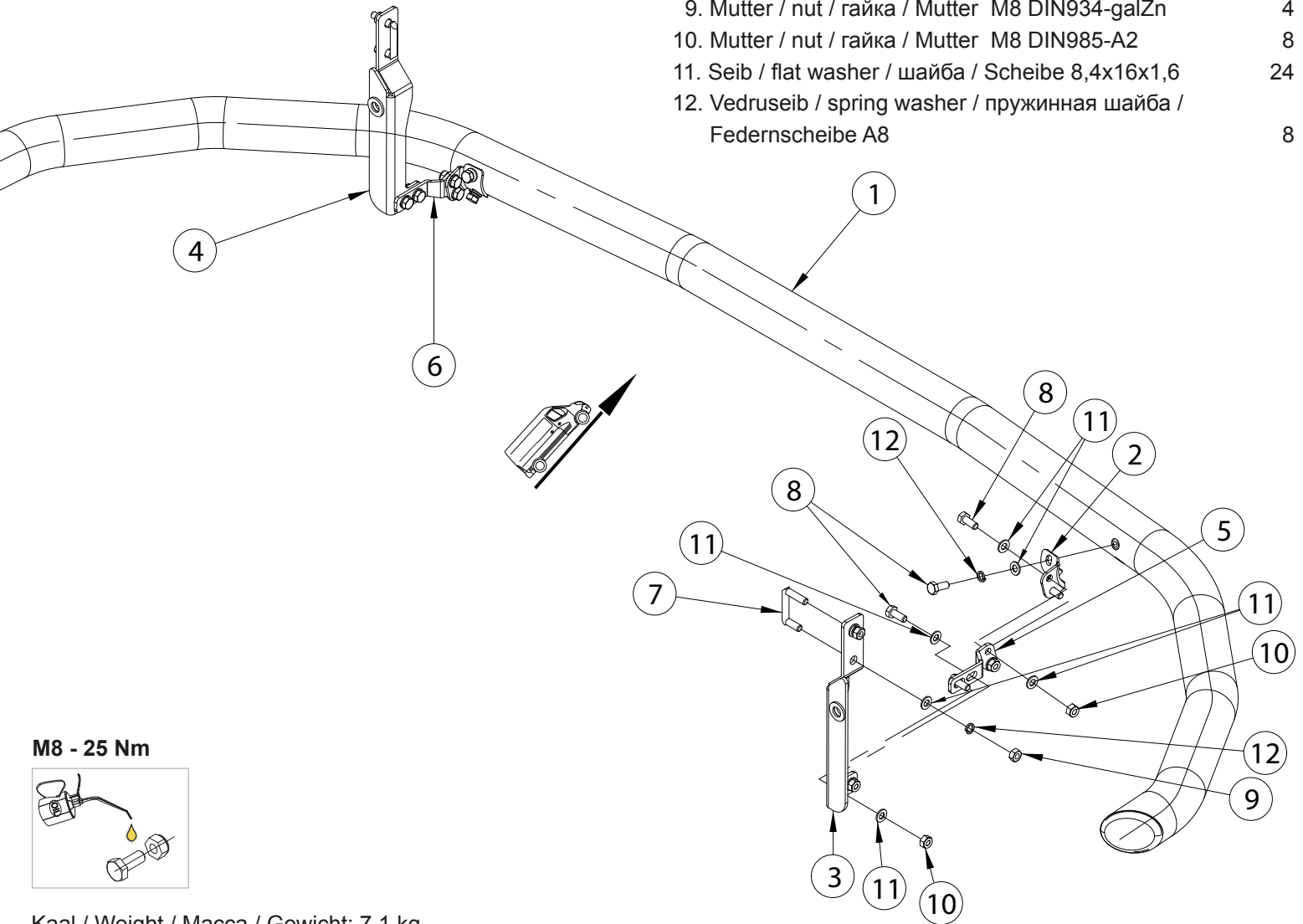

M8 - 25 Nm

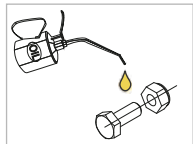

Kaal / Weight / Масса / Gewicht: 7,1 kg

Paigaldusaeg ilma elektritöödetä / Time of mounting w/o wiring works / Время установки без электромонт. работ / Einbauzeit ohne elektrische arbeit: 45 min

Vajalikud tööriistad / Required Tools / Необходимые инструменты / Benötigte Werkzeuge

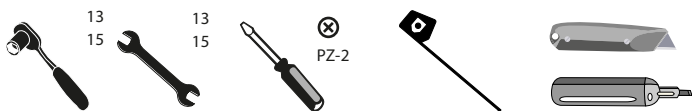

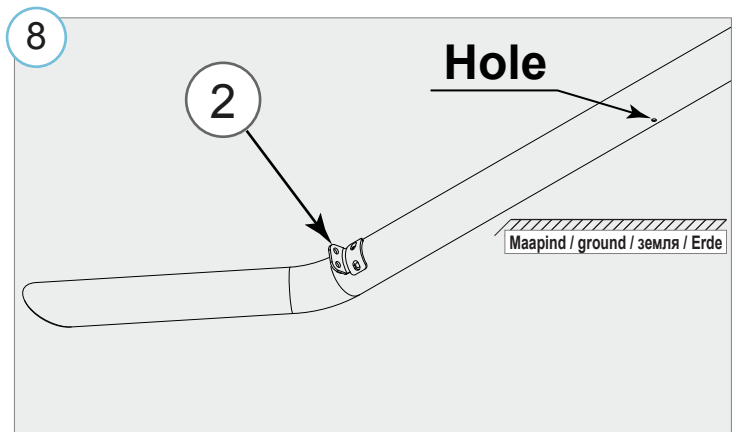
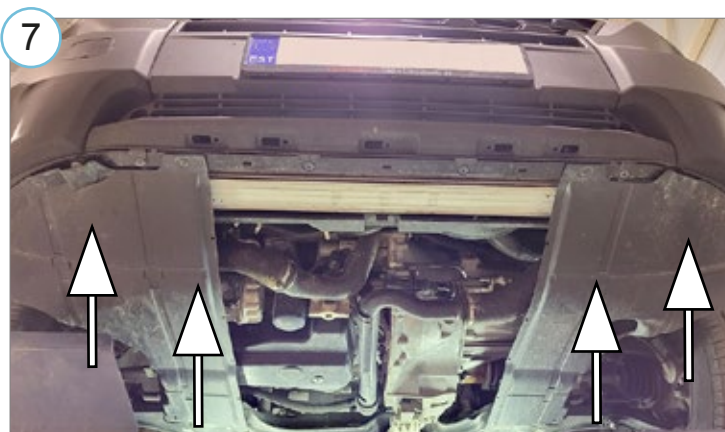
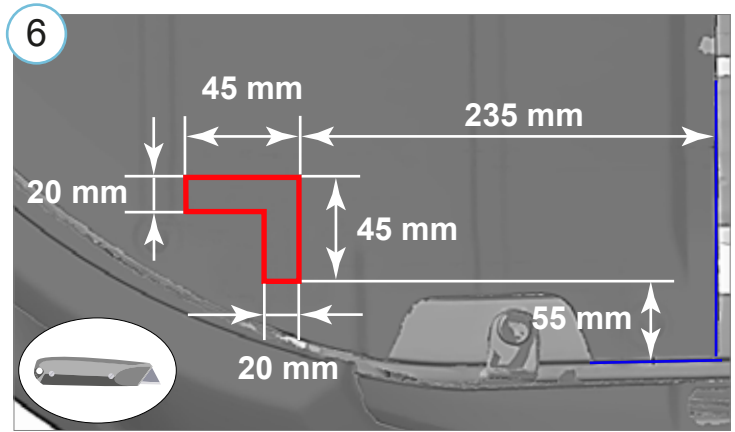
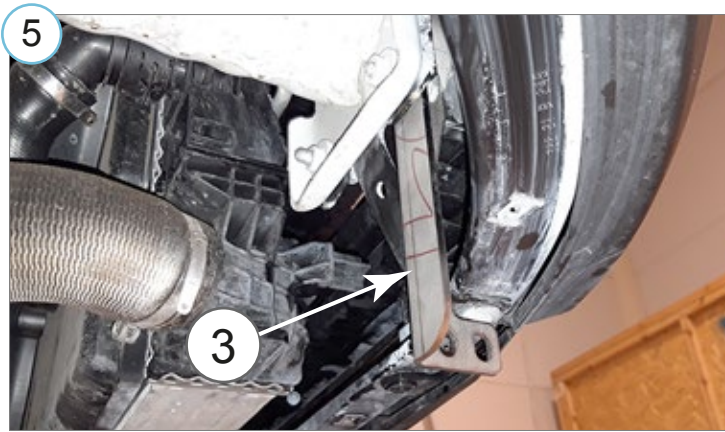
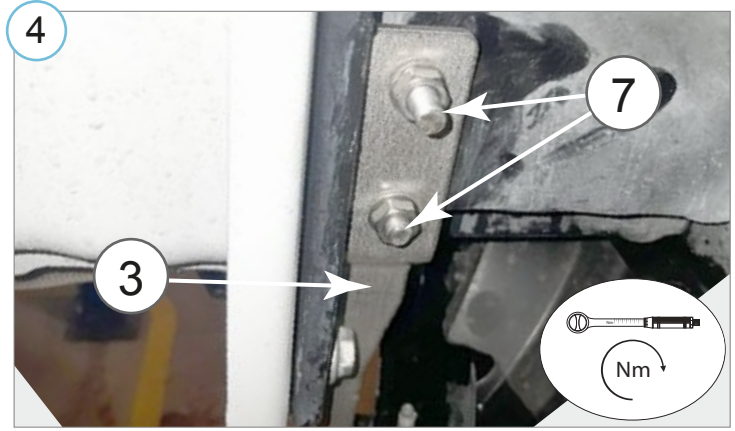
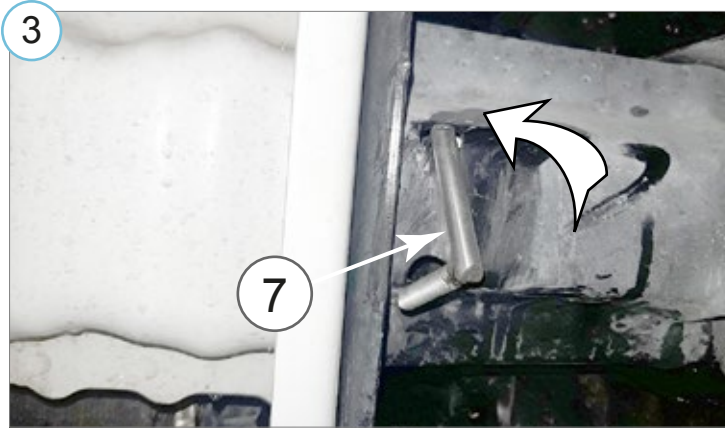
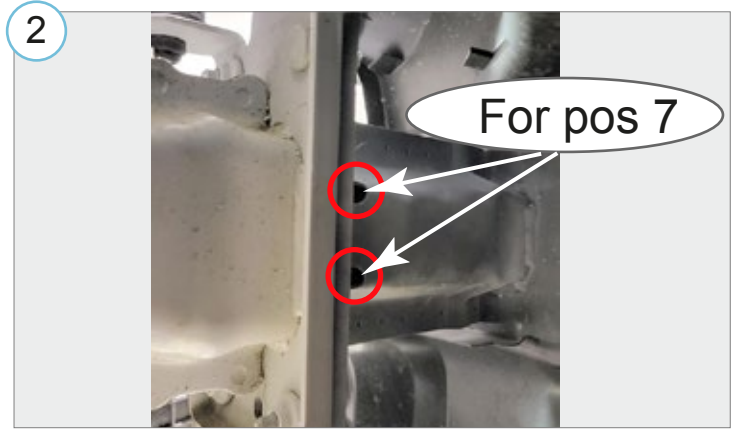
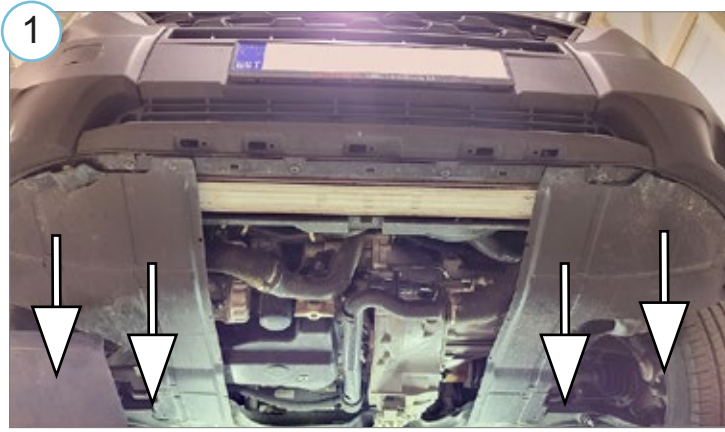

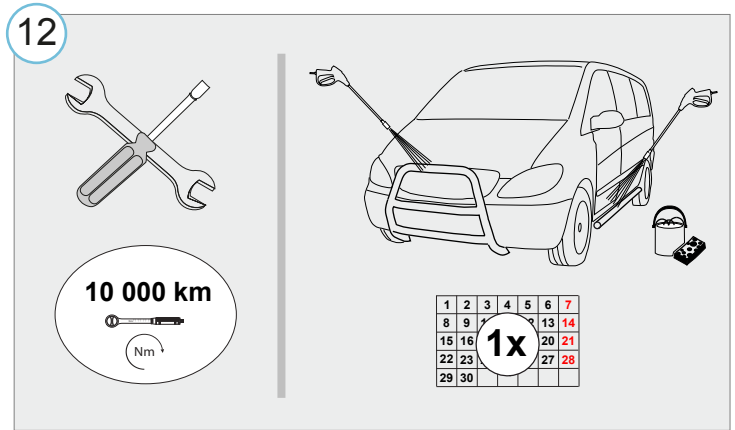
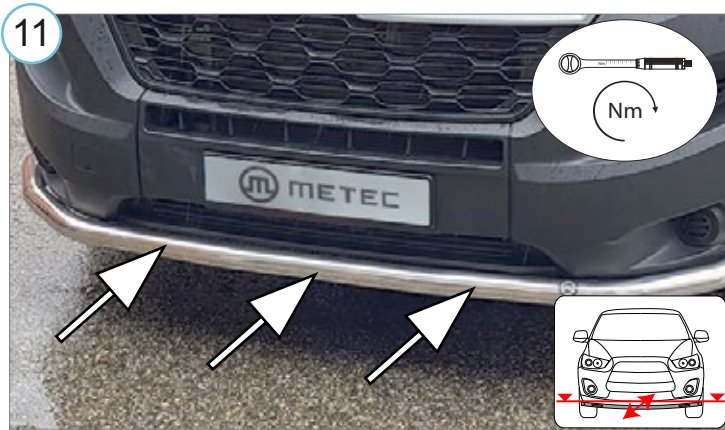
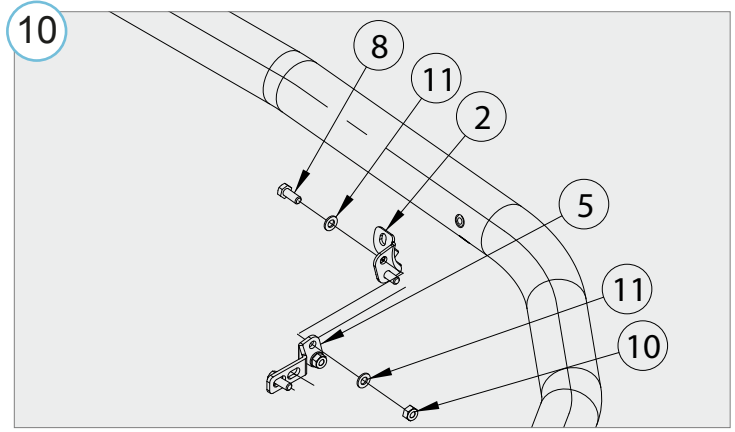
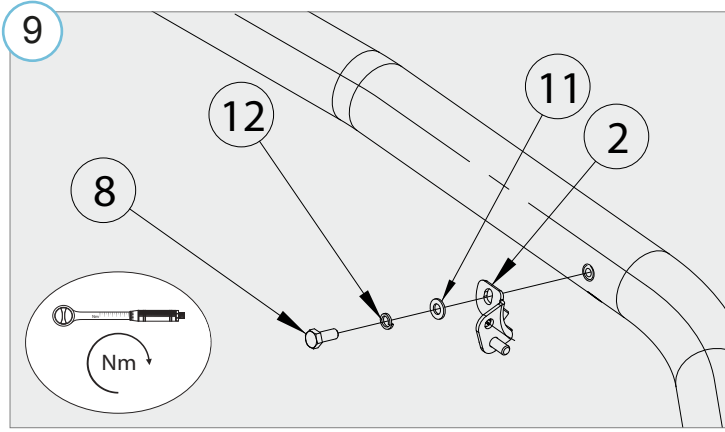

• Kui METEC toode ei vasta Teie ootustele või kui on tegemist toote ebapiisava kvaliteediga, siis pretensioonid esitada lehel www.metec.ee
 • If the METEC product does not meet Your expectations or if it is a product of insufficient quality, then you can submit a claim at www.metec.ee
 • Если METEC продукт не соответствует Вашим ожиданиям или это продукт недостаточного качества, то претензию предъявить можно на сайте www.metec.ee
 • Wenn METEC Produkt nicht Ihren Erwartungen entspricht oder wenn es um Qualitätsmängel geht, dann bitte die Ansprüche auf Seite www.metec.ee einreichen